

# Steel Trim Profiles

First Choice  
EXTERIORS

*Classic*  
METALS



[www.firstchoiceexteriors.com](http://www.firstchoiceexteriors.com)  
[www.classicmetals.com](http://www.classicmetals.com)

● #603 RF 4x4 Corner 12.25" Girth

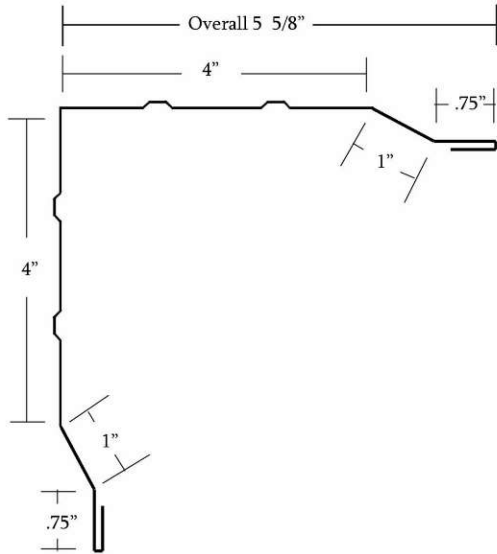

● # 701. 3X3 Corner 10" Girth.

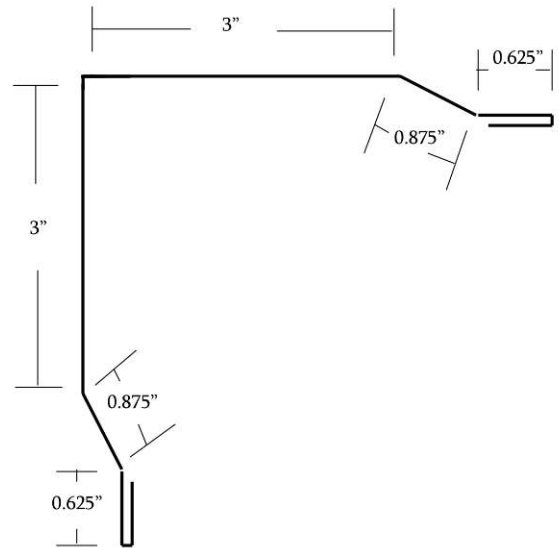

● # 703 4x4 Inside Corner 12.5" Girth

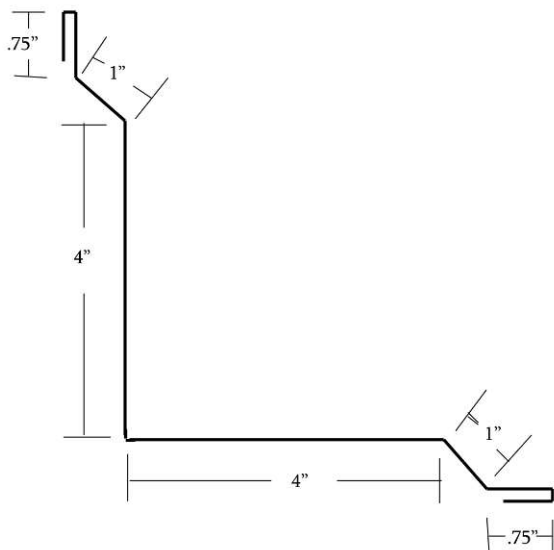

● # 704 Jumbo Corner 21.5" Girth.

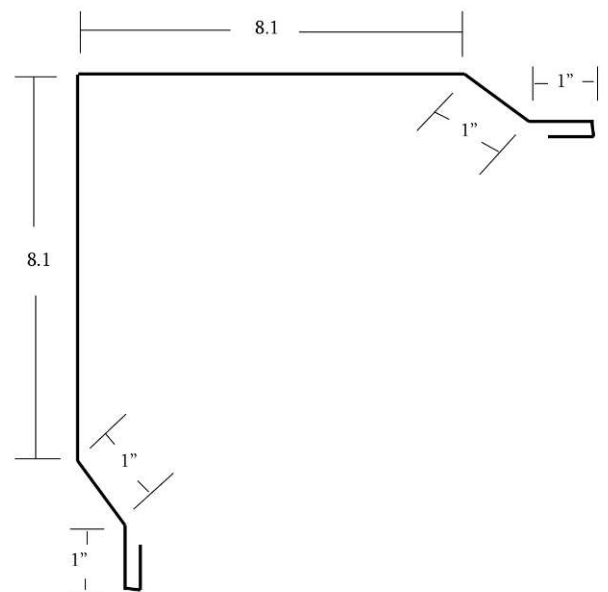

● #604 RF Eave 4.5" Girth

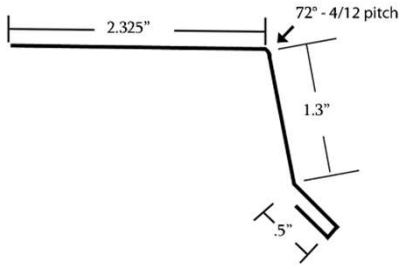

● # 102.Eave 5.25" Girth.

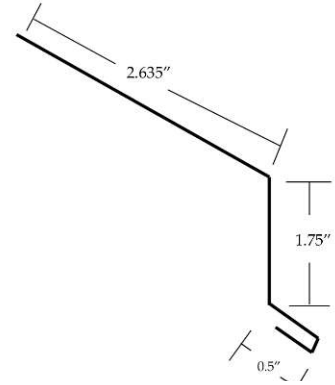

● #103 Eave 6.875" Girth

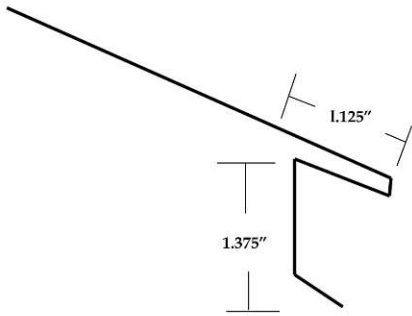

● #104 Eave 5.052" Girth

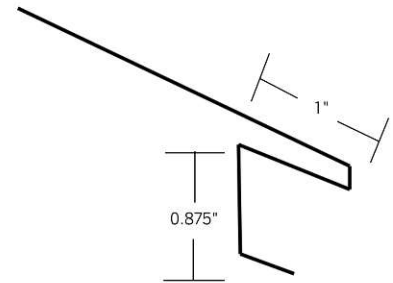

● #105 Eave 4" Face Drip  
10" Girth

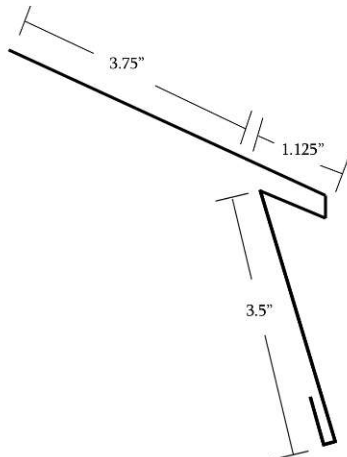

● #106 Eave Drip Cover 7.25" Girth

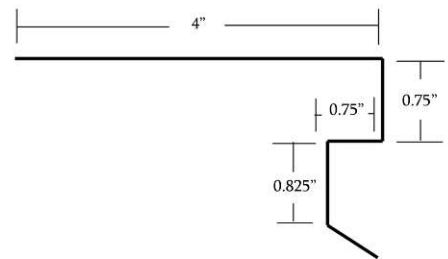

# 609 RF 4" F.C. 6" Girth.

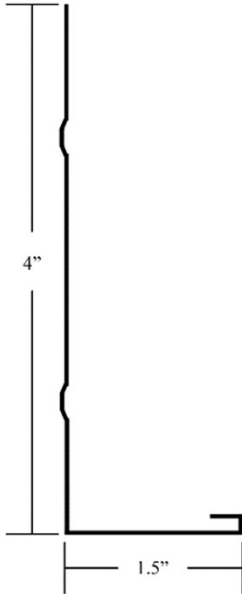

# 610 RF 6" F.C. 8" Girth.

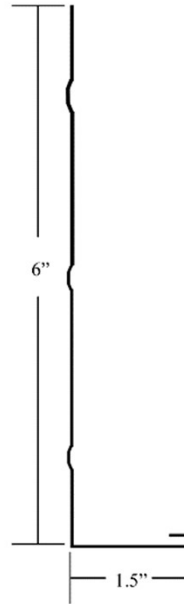

# 611 RF 8" F.C. 10" Girth.

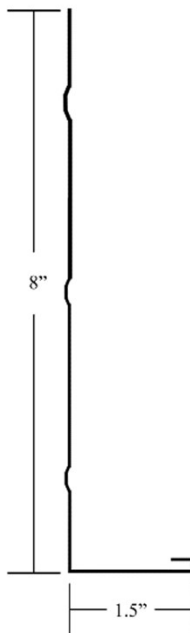

# 803 6" F.C Small 7.25" Girth.

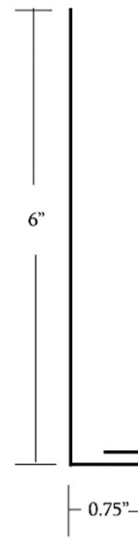

● #004 Garage Door Trim  
13.625" Girth w/ 7" leg

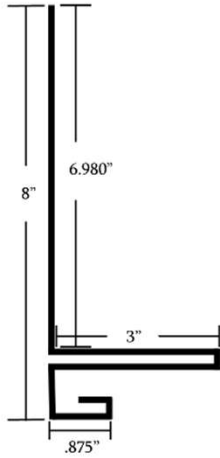

● #006 Stone Drip 4.375" Girth.

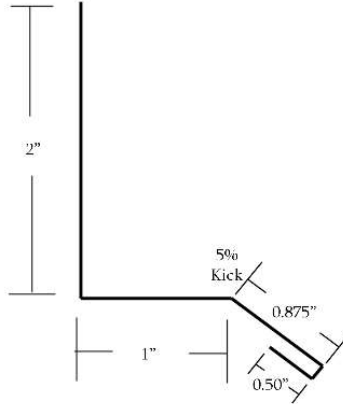

● #007 Counter Flash

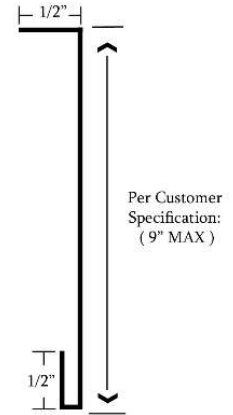

● #008 Water Diverter 6" Girth

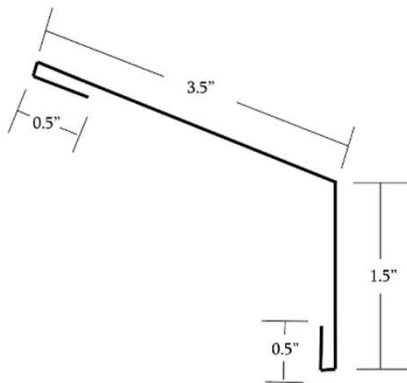

● #009 Garage Door Trim  
14.625" Girth w/ 8" leg

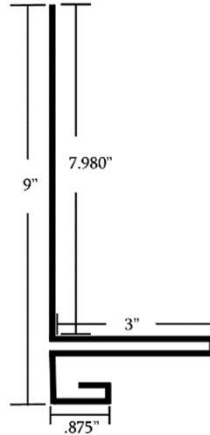

● # 911 Freize 8" Girth

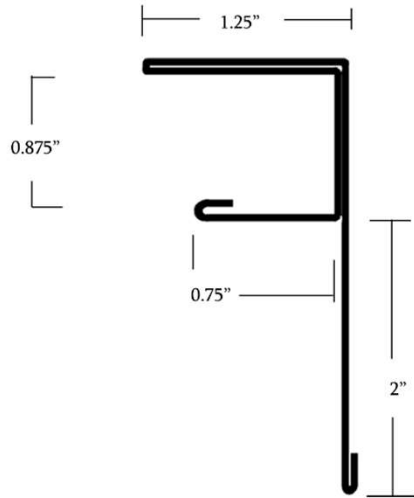

● #912 Soffit / Freize 14" Girth

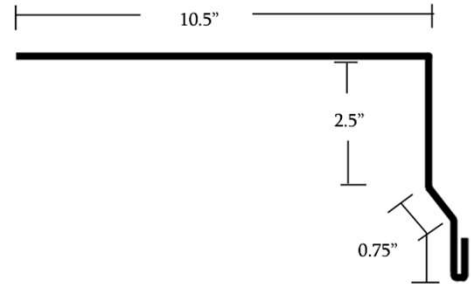

● #303 Flush Gambrel 10" Girth

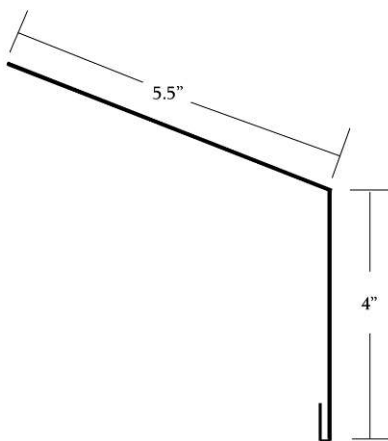

● #303-B Reverse Gambrel 10" Girth

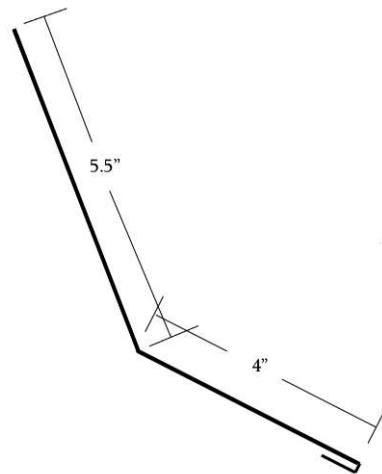

- #214 EG Gable 8.875" Girth

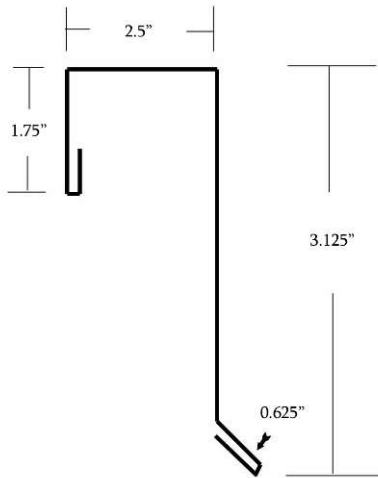

- # 214 EG Base. 5.375" Girth.  
Profile Fits 214 Gable.

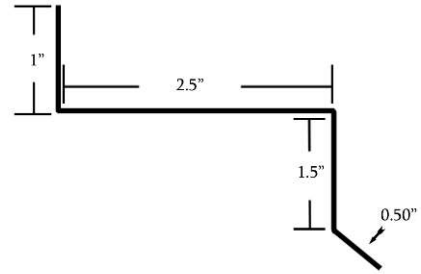

- #212 W.L. Gable 8" Girth

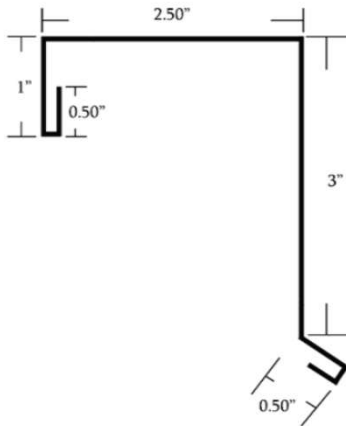

- #212 W.L. Gable Base 5.625" Girth Profile fits 212 Gable

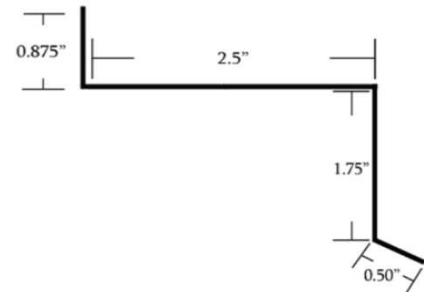

- #608 RF 7/8" J 4.5" Girth.



- # 905 DBL 7/8" J F 8" Girth.

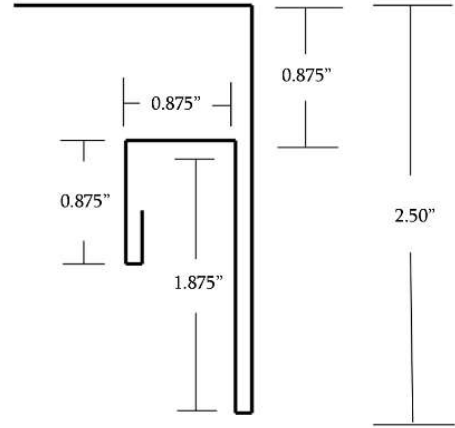

- # 913 7/8"x 1/2" J F 8" Girth.

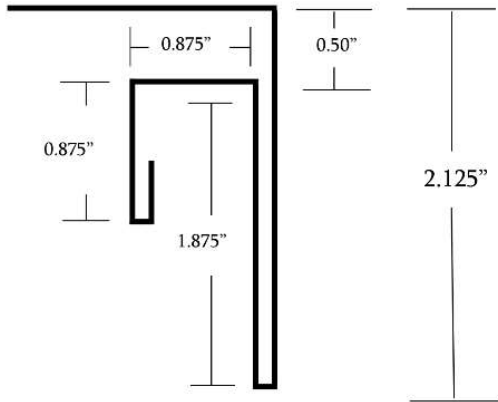



● #204 Res Rake 10" Girth

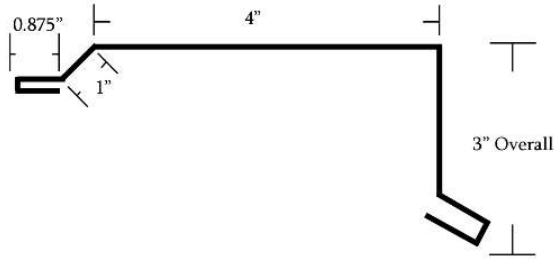

● #602 RF Offset Gable 10" Girth.

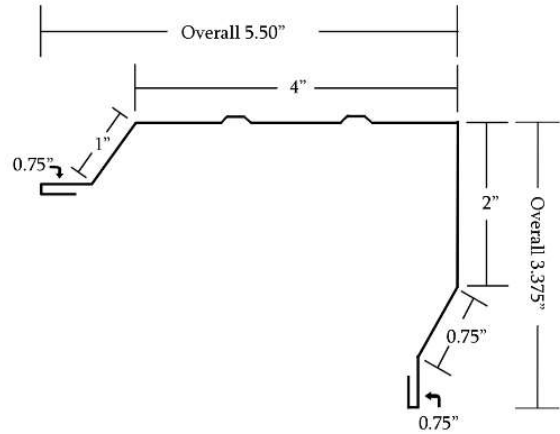

●

# 607 RF Rat Guard 4.5" Girth.

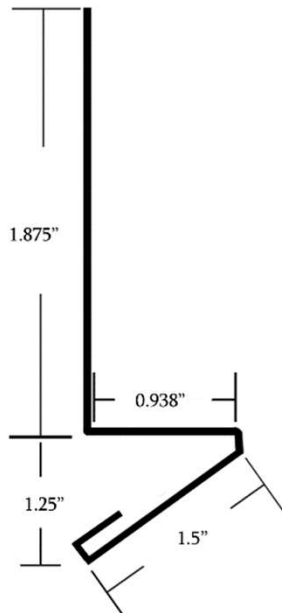

● # 003 Tall Rat Guard 5.5" Girth

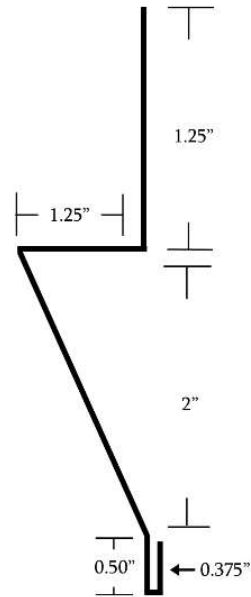

● # 301 Ridge Hip 11" Girth

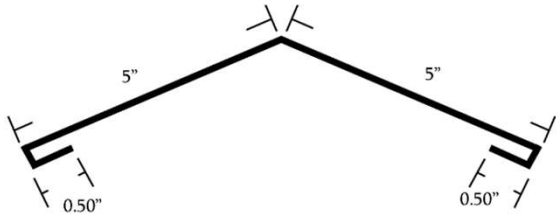

● # 301 Ridge Hip SS 11.75" Girth

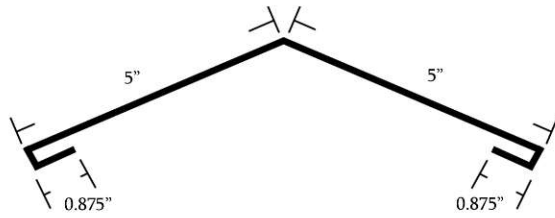

● # 302 Ridge SS 17" Girth.

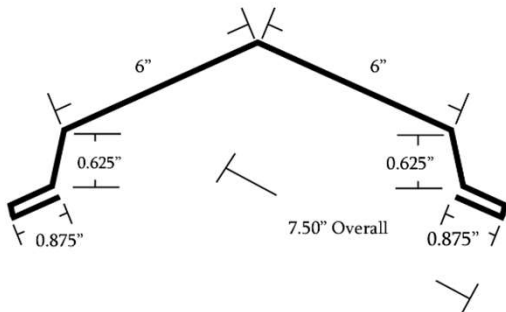

● # 304 Double Drop Ridge 15" Girth.

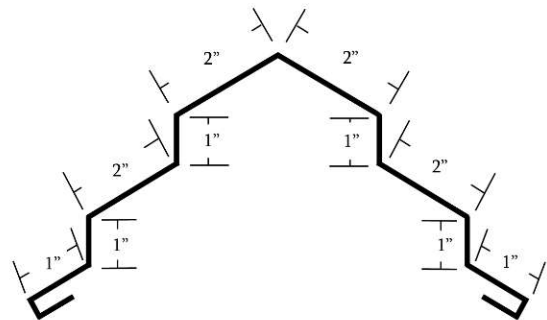

● # 306 Flush Ridge SS  
21 3/4" Girth.

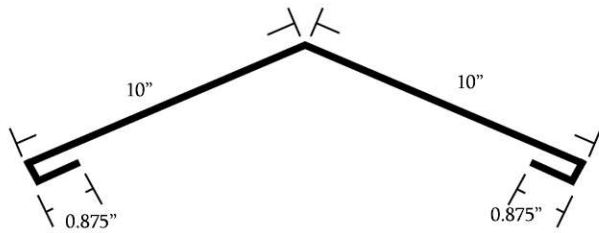

● # 307 Wide Ridge S.S. 20" Girth.

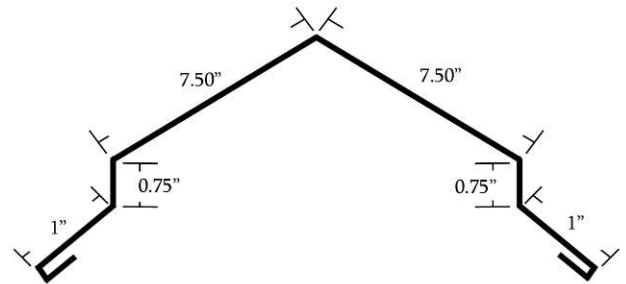

● #601 RF Mini Ridge 13.63" Girth

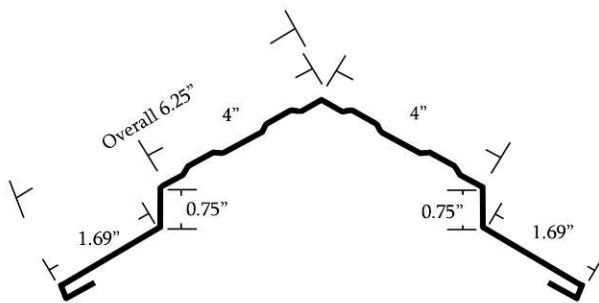

● #605 RF Snow Bar 5.75" Girth

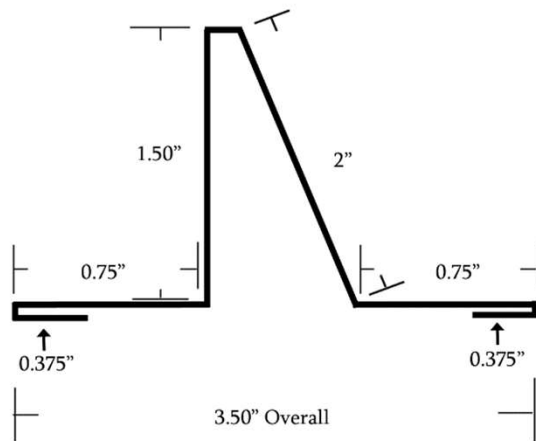

● # 509 CR Transition 13.625" Girth.

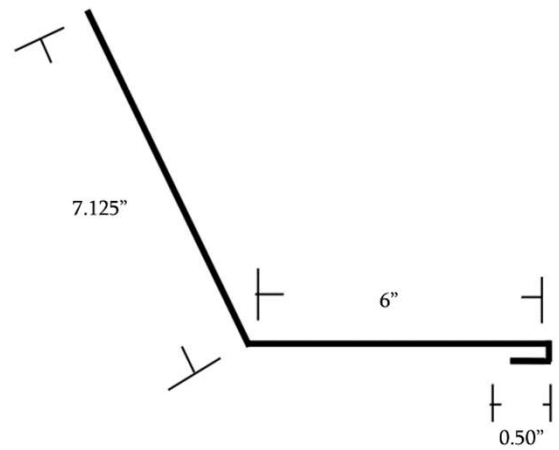

● #513 Transition SS 20" Girth

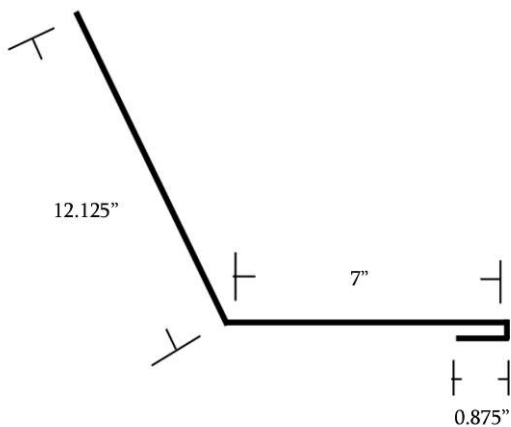

● # 501. Reg EG Valley 20" Girth.

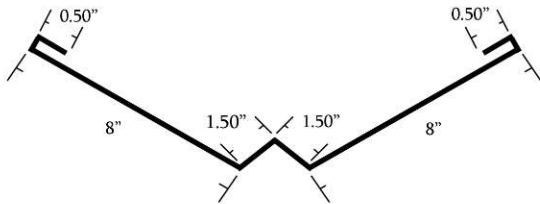

● #502 Reg WL Valley 20" Girth

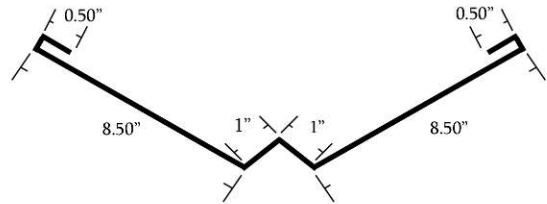

● #505 EG Valley 24" Girth

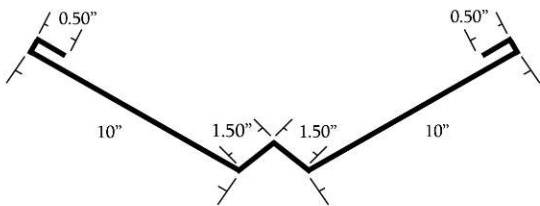

● #506 Valley Cleat 3" Girth

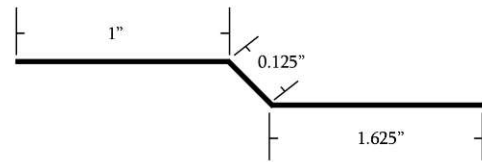

● # 507 Dam 20" Girth.

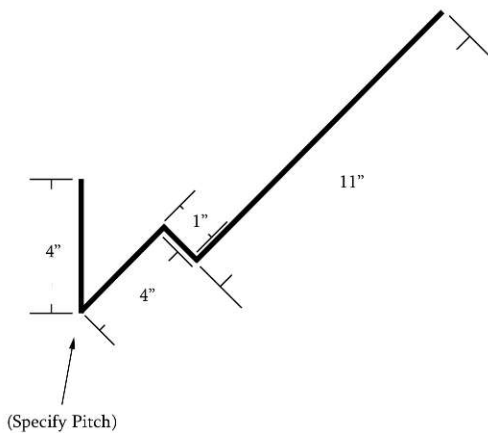

● # 401 Side Wall. 10" Girth.

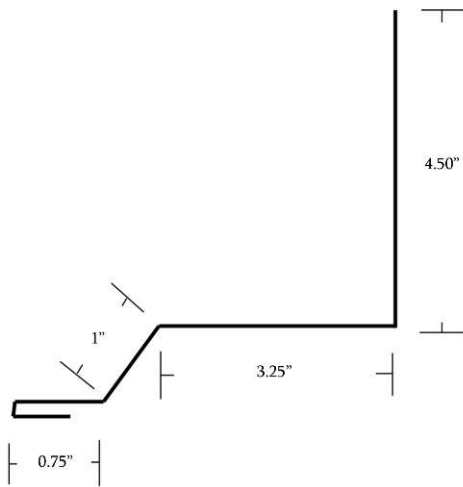

● # 402 Head Wall. 10" Girth.

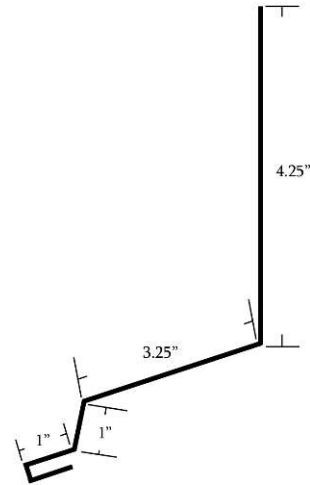

● #403. Reg SSeam Side Wall.  
8" Girth.

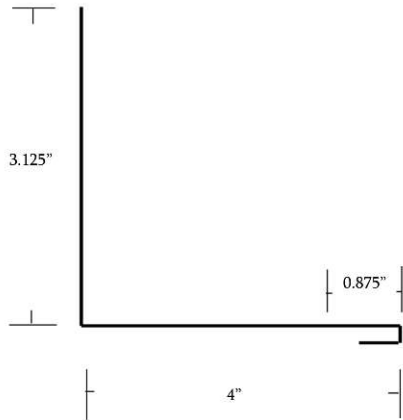

● # 405. Flush Head. 10" Girth.

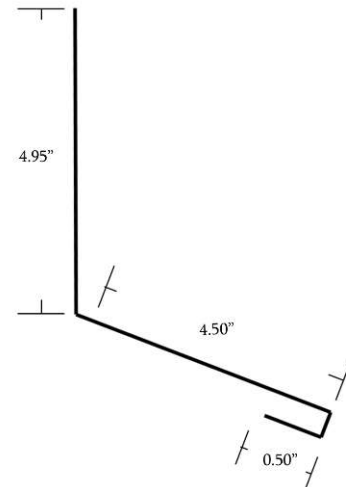

● # 408 Reg S.Seam Headwall  
10" Girth.

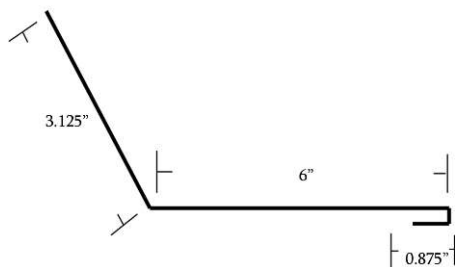

● # 906 Vented 1" Z 3.875" Girth

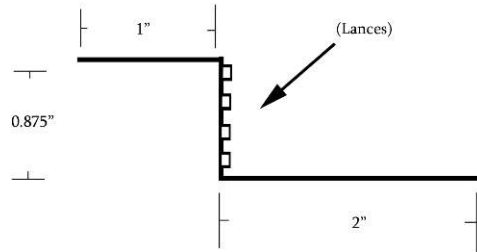

● # 907 Vented 1.75" Z 3.75" Girth

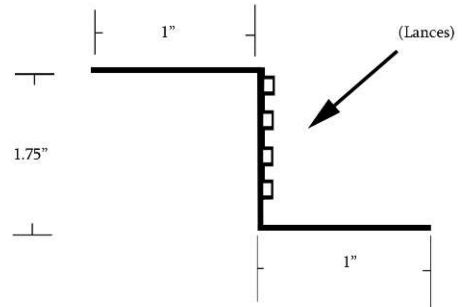

● # 908 Solid 1" Z 3" Girth

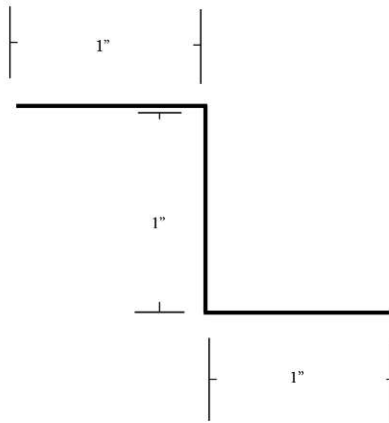

● # 909 Solid 1.75" Z 4" Girth

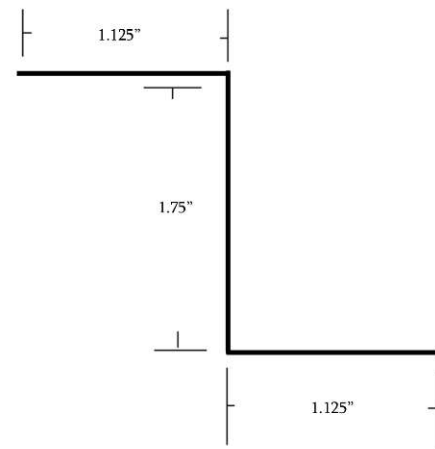

● #606 RF Step Z 4.50" Girth

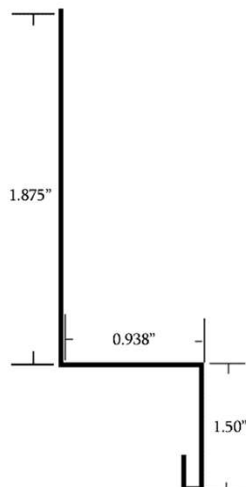

Side Rail

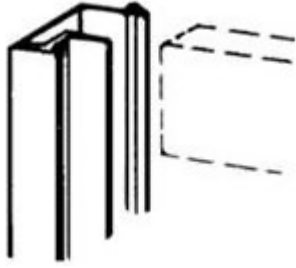

Kwik Frames are stocked in: 8, 10 and 14 foot lengths.

Cannonball Tracks are stocked in: 10, 12, 16 and 20 foot lengths

Double-Couple

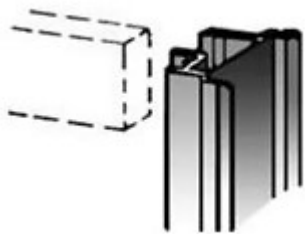

Face Mount for Track & Cover



Face Mount for Track Only



End Cap

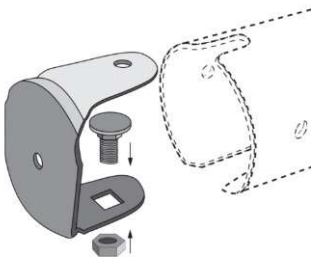

Key-hole Track



Splice Collar

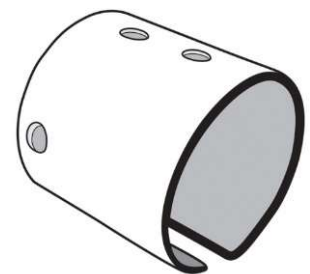

Trolley Hanger

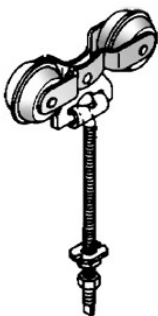

Stay Roller

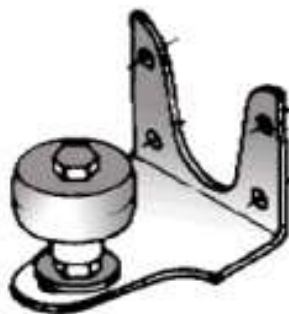

7" Jamb Latch

